

### ARC ADJUSTMENT

The I-20 pop-up sprinkler should be installed at finished grade as shown in the illustration (Fig. 1).

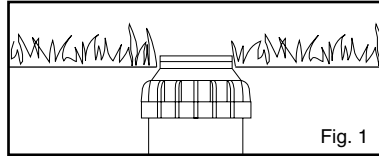

#### Arc Adjustments:

Adjustable heads are preset to approximately 180°. Sprinklers may be adjusted with water on or off. It is recommended that initial adjustments be made before installation.

- Using the palm of your hand, rotate the nozzle turret counterclockwise to the left stop to complete any interrupted rotation cycle (Fig. 2).
- Rotate the nozzle turret clockwise to the right stop. This is the fixed side of the arc. The nozzle turret must be held in this position for arc adjustments. The right stop does not change.

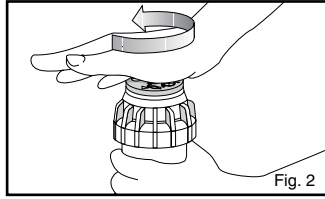

#### To Increase the Arc:

- Insert the plastic key end of the Hunter wrench into the adjustment socket (Fig. 3 & 4).
- While holding the nozzle turret at the right stop, turn the wrench clockwise. Each full 360° turn of the wrench will increase the arc 90°.
- Adjust to any arc between 50° and 360° (Fig. 5).
- The wrench will stop turning, or there will be a ratcheting noise, when the maximum arc of 360° (full-circle) has been reached.
- When set to 360°, the sprinkler will rotate continually counter-clockwise.**

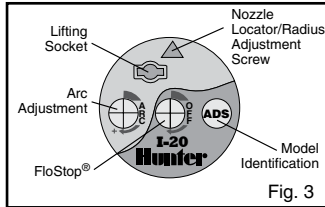

#### To Decrease the Arc:

- Insert the plastic key end of the Hunter wrench into the adjustment socket (Fig. 3 & 4).
- While holding the nozzle turret at the right stop, turn the wrench counterclockwise. Each full 360° turn of the wrench will decrease the arc 90°.
- Adjust to any arc between 50° and 360° (Fig. 5).
- The wrench will stop turning, or there will be a ratcheting noise, when the minimum arc of 50° has been reached.

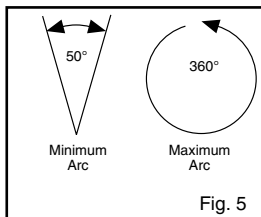
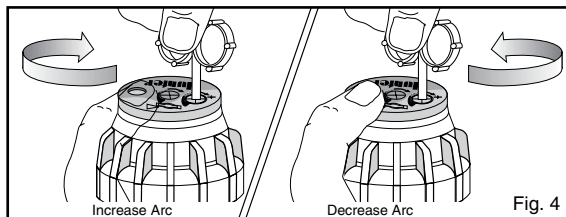

**Note:** It is not necessary to disassemble the sprinkler to make adjustments.

### RADIUS / DISTANCE OF THROW

Insert the steel hex end of the Hunter wrench into the radius adjustment screw (Fig. 6). Turn the screw clockwise (into the stream of water) to decrease the radius, or counterclockwise to increase the radius. Radius can be reduced up to 25%.

**Caution:** Turning the adjustment screw clockwise more than five full turns may result in a lost radius adjustment screw.

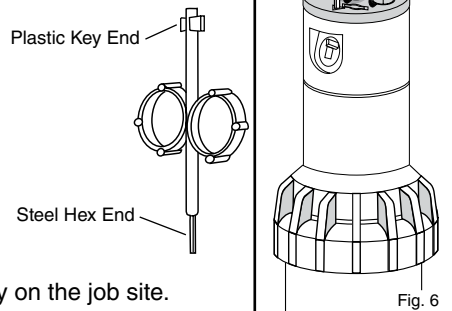

### RECLAIMED ID

All Hunter rotors are available with a purple rubber cover permanently attached. The purple cover shows that reclaimed water is being used for the project, which promotes safety on the job site.

### NON-STRIPPABLE BACKDRIVE

This I-20 sprinkler is designed with an internal device that prevents damage to the internal gear drive if it should be turned by vandals. This important feature works when the nozzle turret is turning in either direction. This makes the sprinkler very durable in all applications.

### AUTO ARC RETURN

This I-20 sprinkler is designed with an internal device that re-aligns the arc if it is turned by vandals. This important feature works when the nozzle turret is turning in either direction. When forced outside of the originally set arc, the sprinkler takes the shortest path back to the pattern without going completely around. This saves the non-irrigated areas from getting wet! Always a good thing!

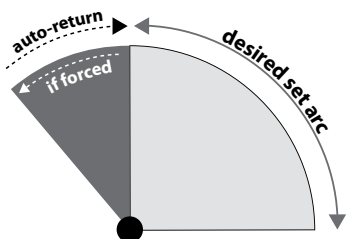

### SHRUB STAKING KIT P/N 463551

The kit is designed for PGP-00 and I-20-00. It allows you to safely attach a shrub sprinkler to a piece of 5/16" rebar. The kit comes with a heavy-duty locking tie to attach the sprinkler to the kit.

### NOZZLE INSTALLATION

- Insert the plastic key end of the Hunter wrench into the lifting socket of the sprinkler and turn 90°. Pull the riser up to gain access to the nozzle socket (Fig. 8).
- Using the hex key of the Hunter wrench, turn the radius adjustment screw (Fig. 6) counterclockwise to be sure it is not blocking the nozzle socket opening. If a nozzle is already installed, it can be removed by backing out the adjustment screw and turning on the water, or by pulling outward on the nozzle removal post with a pair of needle-nosed pliers.
- Slip the desired nozzle into the nozzle socket (Fig. 7). Note that the socket is angled up 25°. Then tighten the nozzle range screw. The triangle on the rubber cover will always indicate the location of the nozzle and direction of water flow when the sprinkler is retracted.

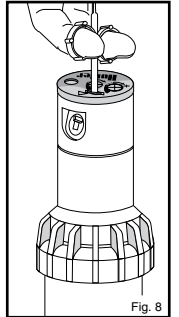
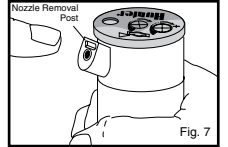

### ALIGNING THE RIGHT (FIXED) SIDE OF ARC

If the right side of the arc is not properly aligned, the results may be a wet walkway or a dry turf area. The right side arc can easily be realigned. One way to realign the right stop is to turn the whole sprinkler body assembly and the fitting below it, left or right to the desired position. This may require temporary removal of the soil around the sprinkler to allow you to grip the sprinkler housing.

Another way to reset the right arc is to unscrew the body cap counterclockwise and remove the internal assembly from the body. Once removed, rotate the nozzle turret to the right stop, screw the internal assembly back into the body with the nozzle aligned to the right side of the area you want irrigated (Fig. 9). At this point you have realigned the right arc stop, and you can adjust the left arc to an appropriate setting.

**Note:** It is not necessary to dig up and remove the whole sprinkler to realign the right arc.

### TURNING FLOW ON OR OFF

Insert the plastic key end of the Hunter wrench into the FloStop® adjustment socket (Fig. 3 & 10). Turn wrench clockwise to decrease or shut off the flow. Turn the wrench counterclockwise to increase the flow.

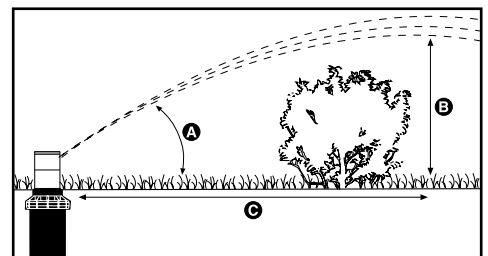
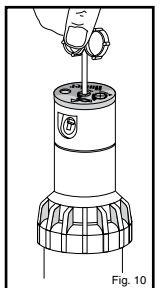
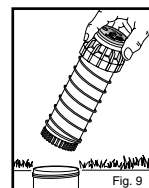

Model	Nozzle No.	Pressure in PSI	A Degrees of Trajectory	B Max Height of Spray (ft.)	C Distance from head (ft.) to Maximum Height
I-20 Blue	1.5	45	25	8'	23'
	2.0	45	25	8'	23'
	2.5	45	25	9'	26'
	3.0	45	25	10'	28'
	4.0	45	25	11'	30'
	5.0	45	25	11'	30'
I-20 Low Angle	6.0	55	25	12'	32'
	8.0	55	25	13'	32'
	2.0	50	13	5'	22'
	2.5	50	13	4'	22'
	3.5	50	13	4'	22'
	4.5	50	13	4'	22'
I-20 18' Short Radius	.50	50	15	5'	8'
	1.0	50	14	6'	9'
	2.0	50	3	1'	6'
I-20 25' Short Radius	.75	50	22	7'	13'
	1.5	50	18	7'	13'
	3.0	50	8	1'	6'

